

www.idkeyco.com



“No Brainer Advertising for Automotive Dealers”

FINALLY, advertising that stays with your customer and will not be thrown away.

FINALLY, advertising that actually saves you money.

FINALLY, advertising that will last the lifetime of the vehicle.

Dealers now have a strong way to advertise in the changing market and at the same time, stretch their dollar further. This new key, the ID Key, will give you a unique and fresh way to promote your dealership, reduce inventory, and save money.

You're buying the keys anyways, why not have your name on it.

ID Key has over 25 years of experience with automotive locks, keys, key machines, and key storage systems. We serve the automotive industry exclusively, supplying the ID Key, classic key blanks, transponder key blanks, integrated remote keys, automotive locks, key machines and key storage systems.



Phone: (780) 451-3202

Toll Free: 1-866-557-3225

Fax: (780) 451-1982

Toll Free: 1-866-557-3226

5863 — 166 Avenue
Edmonton, AB T5Y 0J2, Canada

www.idkeyco.com



ID Key – More Than Just A Key



ID Key is a unique and cost-effective way to promote your company. A single ID Key can be used in place of your manufacturer keys, making a versatile addition to your inventory.

Key chains and other promotional materials are often discarded, but everyone keeps a working key. The embedded logo is designed to last the lifetime of the key

so the advertising benefit lasts as long as the life of the vehicle. ID Keys are manufactured by OEM manufacturers and guaranteed to work.

Getting started with ID Key is simple and easy with no extra setup fees. You get your custom logo imprinted the way you want. Unlike many other promotional items, ID Keys are not limited by colors, giving more freedom to your logo design.

2010 High Security Keys

CHEVY CAMARO, CHEVY EQUINOX, GMC TERRAIN & BUICK LACROSSE



4 Button Remote

5912543 (OE# 13504200)
CHEVY Camaro/Equinox - Side Mill

5912547 (OE# 13504258)
GMC Terrain - Side Mill

5912555 (OE# 13504205)
BUICK Lacrosse - Side Mill

5912558 (OE# 13504203)
BUICK Lacrosse - PEPS



5 Button Remote

5912545 (OE# 13504199)
CHEVY Camaro/Equinox - Side Mill





























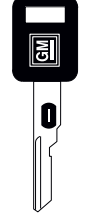

5912548 (OE# 13504259)
GMC Terrain - Side Mill

5912556 (OE# 13504204)
BUICK Lacrosse - Side Mill

5912559 (OE# 13504202)
BUICK Lacrosse - PEPS



General Motors Key Blanks

<p>320404</p>  <p>56E GRV OE# 01154606 EZ# P1098E, B44</p>	<p>320405</p>  <p>57H GRV OE# 01154607 EZ# S1098H, B45</p>	<p>320470</p>  <p>58J GRV OE# 01154608 EZ# P1098J, B46</p>	<p>320471</p>  <p>59K GRV OE# 01154609 EZ# S1098K, B47</p>	<p>320588</p>  <p>50A GRV OE# 01154610 EZ# P1098A, B48</p>	<p>320589</p>  <p>51B GRV OE# 01154611 EZ# S1098B, B49</p>	<p>320652</p>  <p>54C GRV OE# 01154604 EZ# P1098C, B50</p>	<p>320653</p>  <p>55D GRV OE# 01154605 EZ# S1098D, B51</p>
<p>321622</p> <p>W-Body</p>  <p>55D GRV OE# 12390306 EZ# S1098WD, B67</p>	<p>321951</p>  <p>57H GRV OE# 12506490 EZ# S1098WH, B79</p>	<p>322177</p>  <p>75 GRV OE# 16627169 EZ# 51105, B85G</p>	<p>593196</p>  <p>50A GRV OE# 01154610 EZ# B48PC, *B48</p>	<p>593197</p>  <p>51B GRV OE# 01154611 EZ# B49PC, *B49</p>	<p>593719</p>  <p>55D GRV OE# 20373651 EZ# B51P, *B51</p>	<p>593942</p> <p>Beretta-Corsica</p>  <p>54C GRV OE# 26004351 EZ# P1098CV, *B63</p>	<p>595313</p>  <p>56E GRV EZ# P1098EV, *B77</p>
<p>594032</p>  <p>54C GRV EZ# B50P, *B50</p>	<p>595311</p>  <p>54E GRV EZ# B44PC, *B44</p>	<p>595198</p>  <p>57H GRV EZ# B45P, B45</p>	<p>595511 - 595525</p>  <p>50A GRV</p>	<p>596222</p>  <p>50A GRV OE# 12547778 EZ# P1103, B83, B89GP</p>	<p>596772 - 596785</p>  <p>75 GRV</p>	<p>597253</p>  <p>88 GRV OE# 26049794 EZ# B92GP</p>	<p>597500</p>  <p>75 GRV OE# 26049133 EZ# *P1102, B86 EZ# B89GP</p>
<p>597749</p>  <p>75 GRV OE# 26053314 EZ# B89GP</p>	<p>598033</p>  <p>88 GRV OE# 02852068 EZ# B93GOP</p>	<p>598512 - 598525</p>  <p>75 GRV</p>	<p>599487</p>  <p>93 GRV</p>	<p>690552</p>  <p>75 GRV OE# 88891799 EZ# B97PT PK3 Transponder</p>	<p>690556</p>  <p>88 GRV OE# 88951932 EZ# B92PT, B103PT PK3 Transponder</p>	<p>690898</p>  <p>75 GRV OE# 15821273 OE# 15821271 OE# 15821267 EZ# B99PT PK3 Transponder</p>	

General Motors Key Blanks

<p>691205</p>  <p>93 GRV EZ# B107-PT PK3 Transponder</p>	<p>691222</p>  <p>93 GRV OE# 89023920</p>	<p>691502 - 691515</p>  <p>75 GRV</p>	<p>692064</p>  <p>88 GRV B103PT5/B97PT5 R/W Transponder</p>	<p>692065</p>  <p>75 GRV</p> <p>OE# 15821273 OE# 15821271 OE# 15821267 EZ# B99PT5 R/W Transponder</p>		<p>692075</p>  <p>B88P</p>	<p>692076</p>  <p>B96P</p>
<p>692138</p>  <p>93 GRV EZ# PT04-PT5 R/W Transponder</p>	<p>692365</p>  <p>OE# 89022364 H3/Chevrolet Colorado</p>	<p>692366</p>  <p>OE# 89022338 H3/GMC Canyon</p>	<p>692383</p>  <p>93 GRV PK3+ Transponder</p>	<p>692931</p>  <p>93 GRV Chevrolet Logo OE# 89024363 ⊕ Transponder</p>	<p>692932</p>  <p>93 GRV GMC Logo OE# 15824470 ⊕ Transponder</p>	<p>692933</p>  <p>93 GRV Cadillac Logo OE# 25847343 ⊕ Transponder</p>	<p>692952</p>  <p>75 GRV OE# 15821269 PK3 Transponder</p>
<p>692953</p>  <p>75 GRV OE# 15821267 PK3 Transponder EZ# PT04-PT</p>	<p>692954</p>  <p>75 GRV OE# 15821271 PK3 Transponder EZ# PT04-PT</p>	<p>692955</p>  <p>75 GRV OE# 15821273 PK3 Transponder EZ# PT04-PT</p>		<p>693121</p>  <p>93 GRV Pontiac Logo OE# 15282677 ⊕ Transponder EZ# B111-PT</p>		<p>693126</p>  <p>93 GRV Buick Logo OE# 12451816 ⊕ Transponder EZ# B111-PT</p>	
<p>693127</p>  <p>93 GRV Saturn Logo OE# 15871576 ⊕ Transponder EZ# B111-PT</p>	<p>693254</p>  <p>93 GRV H2 Logo OE# 15898567 ⊕ Transponder EZ# B111-PT</p>		<p>5902386</p>  <p>OE# 88956263 Grand Prix PK3 Transponder</p>	<p>5903089</p>  <p>93 GRV GM Logo OE# 89024363 OE# 15824470 OE# 15824471 ⊕ Transponder EZ# B111-PT</p>		<p>5912114</p>  <p>75 GRV OE# 19207416 PK3+ Transponder</p>	

General Motors Key Blanks





<p>5913736</p>  <p>Chevrolet Logo OE# 20871320 ⊕ Transponder</p>	<p>5927928</p>  <p>Chevrolet Logo OE# 23286588 Transponder</p>	<p>5927933</p>  <p>GMC Logo OE# 23286589 Transponder</p>	<p>5928092</p>  <p>Chevrolet Logo OE# 23326748 Transponder</p>	<p>5928094</p>  <p>GMC Logo OE# 23326749 Transponder</p>	<p>5928818</p>  <p>GM Logo OE# 23372321</p>	<p>5928819</p>  <p>GM Logo OE# 23326447 ⊕ Transponder</p>	<p>5928820</p>  <p>GM Logo OE# 23322886 PK3 Transponder</p>
<p>5928821</p>  <p>GM Logo OE# 23324801 PK3 Transponder</p>	<p>5928822</p>  <p>GM Logo OE# 23324381</p>	<p>5928823</p>  <p>GM Logo OE# 23322887 PK3+ Transponder</p>	<p>5928824</p>  <p>GM Logo OE# 23343201</p>	<p>5928825</p>  <p>GM Logo OE# 23344370 PK3+ Transponder</p>	<p>7013237</p>  <p>Side Mill Key Blank GM Logo Transponder</p>		

● Available as an ID-Key

General Motors Remotes & Fobs

<p>5922032</p>  <p>OE# 20935330</p>	<p>5922033</p>  <p>OE# 20935331</p>	<p>5922034</p>  <p>OE# 20952475</p>	<p>5922035</p>  <p>OE# 20952474</p>
<p>5922372</p>  <p>OE# 20952476</p>	<p>5922373</p>  <p>OE# 20952477</p>	<p>5922374</p>  <p>OE# 20970807</p>	<p>5922375</p>  <p>OE# 20970808</p>
<p>5912555-5912558-5912543</p>		<p>5912556-5912559-5912545</p>	
 <p>OE# 13504200 OE# 13504203 OE# 13504205</p>	 <p>OE# 13504199 OE# 13504202 OE# 13504204</p>	<p>5915037</p>  <p>Flip Key Remote Replacement Blades and Pins 5 per package</p>	

Cadillac Key Fobs

<p>5923877</p>  <p>Cadillac CTS 4 Button FOB #1 OE# 22889449</p>	<p>5923878</p>  <p>Cadillac CTS 4 Button FOB #2 OE# 22889450</p>	<p>5923879</p>  <p>Cadillac CTS 5 Button FOB #1 OE# 20998255</p>	<p>5923880</p>  <p>Cadillac CTS 5 Button FOB #2 OE# 20998256</p>
<p>5923881</p>  <p>Cadillac CTS Wagon 4 Button FOB #1 OE# 22889451</p>	<p>5923882</p>  <p>Cadillac CTS Wagon 4 Button FOB #2 OE# 22889452</p>	<p>5923883</p>  <p>Cadillac CTS Wagon 5 Button FOB #1 OE# 20998281</p>	<p>5923884</p>  <p>Cadillac CTS Wagon 5 Button FOB #2 OE# 20998282</p>
<p>5923885</p>  <p>Cadillac Escalade 4 Button FOB #1 OE# 22756463</p>	<p>5923886</p>  <p>Cadillac Escalade 4 Button FOB #2 OE# 22756464</p>	<p>5923887</p>  <p>Cadillac Escalade 6 Button FOB #1 OE# 22756465</p>	<p>5923888</p>  <p>Cadillac Escalade 6 Button FOB #2 OE# 22756466</p>
<p>5912534</p>  <p>Emergency Key OE# 20765513</p>			

Lock Cylinders

Ignitions

Single-bitted – Coded Locks

IN-DASH

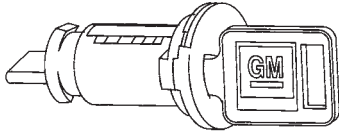

605532

STANDARD SNAP-IN

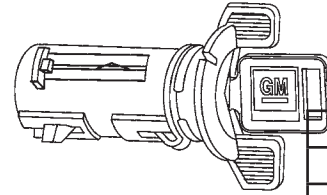

607893

FLEET APPLICATION	
LOCK CODED	GRV
608528	55-D
608529	57-H

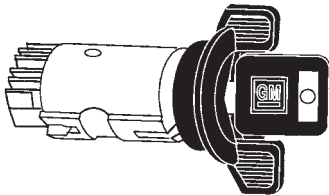

700559

STANDARD BOLT-IN

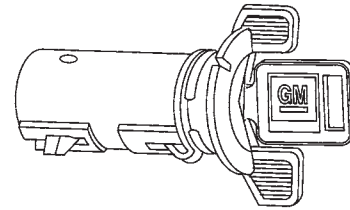

701398
701400 - BLACK
701410 - BLACK PUSH BUTTON

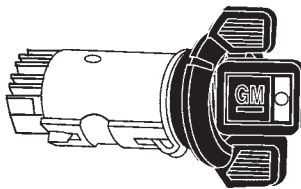

701403

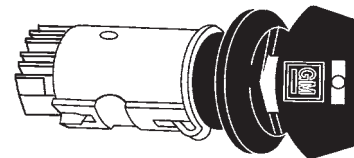

7 TOOTH 701404 701408 - PUSH-BUTTON
8 TOOTH 701405 701403 - PUSH-BUTTON

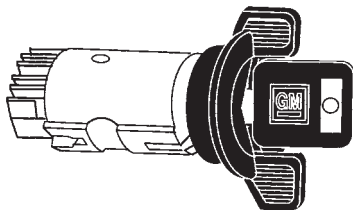

701406
701407 - PUSH BUTTON

MAST BOLT-IN

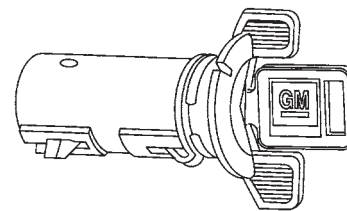

701759
703342 - BLACK

Lock Cylinders

Ignitions (cont.)

Single-bitted PASS Key

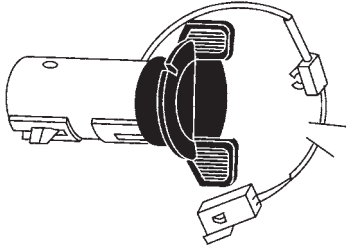

700754
700398 - PUSH-BUTTON

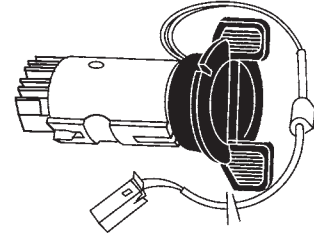

701285

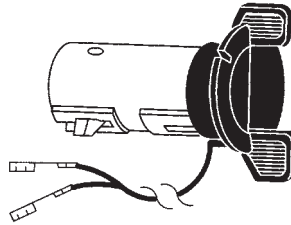

701286

Double-bitted Coded Locks

MODULAR

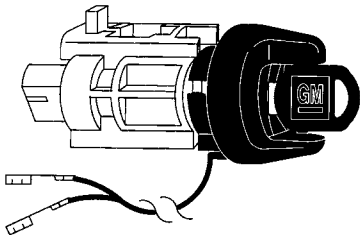

702563

MODULAR

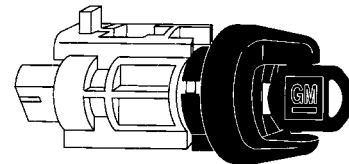

701869
701870 - PUSH-BUTTON

Double-bitted Lock Service Package

IN-DASH

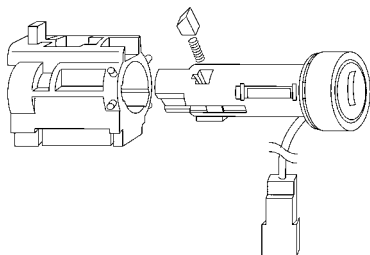

703606

BEZEL



381340

Lock Cylinders

Ignitions (cont.)

Double-bitted Lock Service Package (cont.)

MODULAR

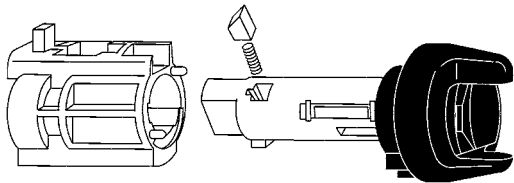

702926
702927 - PUSH-BUTTON

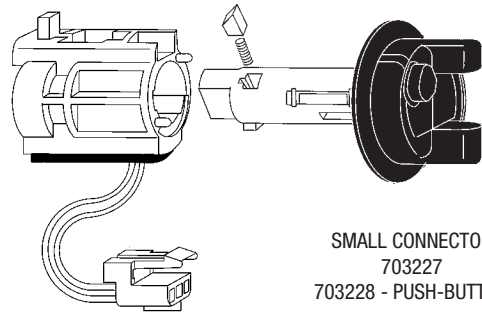

SMALL CONNECTOR
703227
703228 - PUSH-BUTTON

LARGE CONNECTOR
703225
703226 - PUSHBUTTON

TRUCK CSS COLUMN

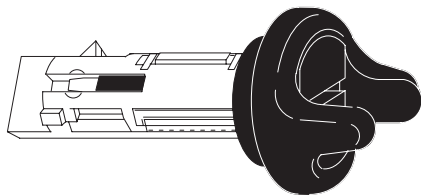

704600 - LG KNOB
704601 - PB - LG KNOB
707758 - LG KNOB - 4 POS. DETENT
707759 - LG KNOB PB - 4 POS. DETENT
707808 - NON MRD
707809 - PB NON MRD

CSS COLUMN 1995 - CURRENT

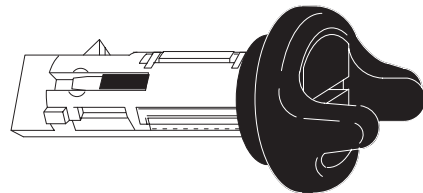

702671
702672 - PUSH-BUTTON
703935 - MRD
703936 - MRD PUSH-BUTTON

TRUCK CSS COLUMN

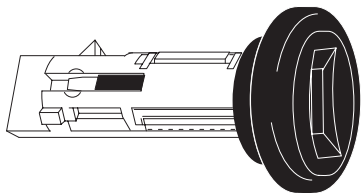

707835
707836 - PB

CSS COLUMN

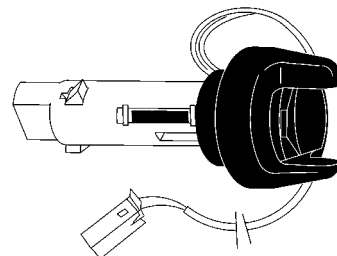

703605

Lock Cylinders

Ignitions (cont.)

Double-bitted Lock Service Package (cont.)

BEZELS

IN-DASH PASSLOCK

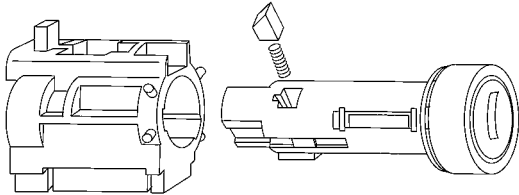

703602



597640



597642
597696 - OPTIC

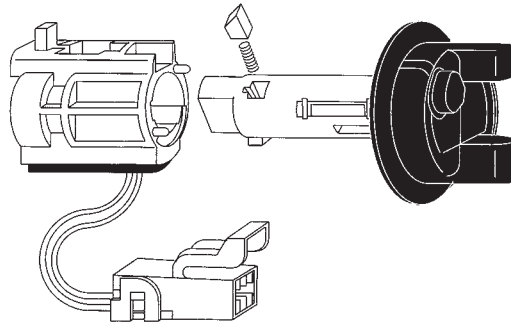

LONG WIRE
703648 - MRD
703649 - PB-MRD

SHORT WIRE
705383 - MRD
705384 - PB-MRD

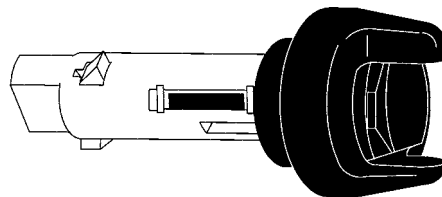





CSS COLUMN RFID
704602

CSS NON-MRD
706570

Lock Cylinder Parts

Tumblers & Springs

Single-bitted				
IGNITION, DOOR, DECK, TAILGATE TUMBLERS		GLOVE, MISC. TUMBLERS		
Side Bar	#1	322051		
	#2	322052		
	#3	322053		
	#4	322054		
	#5	322055		
Spring		46648		
Tumbler Spring Retainer		321127		
	Snap-in	#1	320606	
		#2	320666	
		#3	320667	
		#4	320668	
		#5	320669	
	Spring		46650	
	Retainer Tumbler		320690/320698	
	Retainer Tumbler		321185/321451	
	Retainer Tumbler		321095	













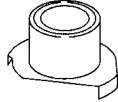



Double-bitted				
IGNITION TUMBLERS		DOOR, DECK, TAILGATE, REAR DOOR TUMBLERS		
Side-bar	#1	321121		
	#2	321122		
	#3	321123		
	#4	321124		
Spring		56028		
Tumbler Spring Retainer		323230		
	Snap-in	#1	322241	
		#2	322242	
		#3	322243	
		#4	322244	
	Spring		46890	

GLOVE, MISC. TUMBLERS				
	Snap-in	#1	322171	
		#2	322172	
		#3	322173	
		#4	322174	
	Spring		46650	
	Retainer Tumbler		322161	
	Retainer Tumbler		322444	
	Retainer Tumbler		322566	



Lock Cylinder Parts























Caps & Shutters

STANDARD	SMALL	OPTIC	STOVE TOP	SNAP CAP	SNAP CAP
					
320395 - CHROME 322658 - BLACK 323226 - LARGE	320318 - CHROME 322657 - BLACK	320969 - CHROME 322659 - BLACK	321314 - CHROME 322555 - BLACK	322144 - CHROME 322667 - BLACK	321598 - CHROME 47603 - SCALP ONLY BLACK
SNAP CAP LANCED	SNAP CAP DOUBLE CUT OUT	EYEBROW	DEEP DISH	S/T TG CASE	PUSH-BUTTON
					
322340 - CHROME	320318 - CHROME	321788 - CHROME	322056 - CHROME	322473 - BLACK	322355 - BLACK 322917 - BLACK
S/T TG MANUAL	SMALL	STANDARD	LANCED	RIVIERA/AURORA EYEBROW	SPRING
					
322661 - BLACK	59995 - CHROME 593555 - BLACK	59885 - CHROME 597819 - BLACK	596870 - CHROME 599466 - CHROME 599465 - BLACK	596918 - CHROME	46912 46766





































Service Kits

SINGLE-BITTED

DOUBLE-BITTED

AMC 					
320318	320376	320395	320395		
					
47522	47544	47544			
RETAINERS					
321127	320690	320698	321185		
PLATE DESIGN					
TUMBLERS 					
46650	320606	320666	320667	320668	320669
SIDE BAR DESIGN					
TUMBLERS 					
46648	322051	322052	322053	322054	322055

608796

					
596918	321788	322161	380715	593555	46986
					
322444	46912	596870	322661	47603	322340
					
47704	321519	380256 R/H	380257 L/H	322355	322355
DOORS, REAR COMPARTMENT, TAILGATE					
					
46890	322241	322242	322243	322244	46934
I.P. GLOVE COMPARTMENT					
					
322171	322172	322173	322174	46650	311496
IGNITION					
					
56028	323121	323122	323123	323124	323230

702767

Ford/GM Side Mill Pinning Kit

STRATTEC PART #7023068



TRUSTED SOURCE. MANY SOLUTIONS.

***APPLICATIONS:**

2012 - CURRENT: GM Buick Verano
 2011 - CURRENT: FORD Fiesta Ign/Door
 2011 - CURRENT: GM Chevy Volt (Door)
 2011 - CURRENT: GM Buick Regal
 2010 - CURRENT: GM Buick LaCrosse
 2010 - CURRENT: Chevy Camaro
 2010 - CURRENT: Chevy Cruze
 2010 - CURRENT: Chevy Equinox
 2010 - CURRENT: GMC Terrain

BOX 1 OF 2

HIGH SECURITY PINNING KIT

STRATpack™

3333 West Good Hope Road | Milwaukee, WI 53209 | 414.247.3333
<http://aftermarket.strattec.com>



©2012 STRATTEC Security Corporation. All Rights Reserved. 4723068 - 1/12

FORD IGNITION & DOOR					
			GM IGNITION		
GM IGNITION & DOOR					

STRATTEC PART #7023068



TRUSTED SOURCE. MANY SOLUTIONS.

***APPLICATIONS:**

2012 - CURRENT: GM Buick Verano
 2011 - CURRENT: FORD Fiesta Ign/Door
 2011 - CURRENT: GM Chevy Volt (Door)
 2011 - CURRENT: GM Buick Regal
 2010 - CURRENT: GM Buick LaCrosse
 2010 - CURRENT: Chevy Camaro
 2010 - CURRENT: Chevy Cruze
 2010 - CURRENT: Chevy Equinox
 2010 - CURRENT: GMC Terrain

BOX 2 OF 2

HIGH SECURITY PINNING KIT

STRATpack™

3333 West Good Hope Road | Milwaukee, WI 53209 | 414.247.3333
<http://aftermarket.strattec.com>



©2012 STRATTEC Security Corporation. All Rights Reserved. 4723068 - 1/12

FORD DOOR					
GM DOOR					
GM R/C					

7023068

Ford/GM Side Mill Pinning Kit

APPLICATIONS:

- 2011-13 Ford Fiesta
- 2012-13 Buick Verano
- 2011-13 Buick Regal
- 2010-13 Buick LaCrosse
- 2011-13 Chevrolet VOLT
- 2010-13 Chevrolet Camaro
- 2010-13 Chevrolet Cruze
- 2010-13 Chevrolet Equinox
- 2010-13 GMC Terrain



Key Cutting Service

Get Any Automotive Key Cut to Code

ID Key can cut any automotive key to code and have it shipped out to you within 24 hours. Call, fax or email us with the key blank or vehicle information and the key code required. We'll have our skilled technicians cut a key to your code and ship it out within 24 hours. We have access to most manufacturers' key blanks and the hardware required to cut them. This includes the new Side Mill and TIBBE keys as well as foreign high security keys.

We can also cut your stocked keys to code. Simply ship your key blank to us with the key code and we'll have it cut and shipped back to you within 24 hours.



Key Duplicating Machines

Bravo III Heavy Duty Semi-Auto Traditional Key Duplicator

- Wide spacing between vise jaws accommodates longer keys, and those with large heads.
- Carriage is spring loaded, provides consistent cutting pressure, and reduces potential for miscuts
- Automatic cutter start feature; activated by raising and lowering carriage
- Depth adjustment is accomplished using a refined dial type configuration; easy to calibrate and accurate, repeatable results
- Two carriage shafts ensure sensitivity and precision in the cutting operation
- “Soft-touch” nylon deburring brush



SPEED 044 Semi-Auto Traditional Key Duplicator

- The spring loaded carriage applies a consistent cutting pressure while in automatic mode
- Four sided, nickel plated jaws for clamping the majority of all edge cut/flat type keys.
- Wide spacing between clamps accommodate large bow (head) and long blade keys, including flip style keys
- Nylon deburring brush
- Two year warranty



SPEED 045 Manual Traditional Key Duplicator

- Four sided, nickel plated jaws for clamping the majority of all edge cut/flat type keys.
- Wide spacing between clamps accommodate large bow (head) and long blade keys, including flip style keys
- Nylon deburring brush
- Two year warranty



Key Code Cutting Machines

Futura Traditional & Side Mill Key Code Cutting Machine

Traditional Keys

- Copy by original with optical reader to ensure an exact duplication of the original
- Decode and copy by optical reader to OEM specifications
- Four position jaw (clamp) accommodates a wide variety of keys without additional accessories or adapters

Side Mill & Laser Cut Keys

- Decode and copy by electrical contact to OEM specifications
- One clamp, three quick change interchangeable jaws included
- Interactive 3rd axis eliminates the need for manual depth of cut adjustment
- Expand capabilities to include Tibbe, tubular and other keys with optional accessories

Touch Screen, Wi-Fi Innovation

- Removable 10" (254 mm) touch-screen tablet provides step-by-step instructions and menu prompts to simplify key selection, position and the key cutting process
- Wi-Fi enabled communication between tablet and machine
- Silca® database provided is the most extensive database available
- 10 different search criteria
- Multi-language support

Work Efficiency

- Automatic calibration
- Software database updates via direct Wi-Fi connectivity or download to PC
- LED lighting indicates current status of machine
- Safety shield retracts into the hood



Key Code Cutting Machines

Tri-Code Side Mill Key Duplicator & Code Cutting Machine

- Microprocessor controlled cutting operation, utilizing a precision x-y stepper motor carriage transport mechanism
- Extensive “on-board” database contains cut specifications for dozens of sidewinder/laser style automotive key systems and also includes indirect codes for most major automotive brands using sidewinder/laser style keys
- Versatile Three-Position vise clamp (optional vises are not required)
- Only one cutter required to support all applications
- Simple to follow menus with easy view LCD display and generous size keypad for easy operation
- Built-in light illuminates cutting area
- Protective safety shield



Pak-A-Punch Traditional Key Punch Machine

- The Valu-Set is A-1's best value.
- Purchased as separate components, this package would cost hundred's of dollars more.
- Includes PAK-A-PUNCH Model 3T plus all accessories for punching General Motors 10-Cut, General Motors 6-Cut, Chrysler Double Sided ('92-'97), late model Chrysler 8-cut, Ford 8-Cut, Ford 10-Cut (including 10-cut ignition plus 5-cut door / trunk) plus some late model Jeep, Eagle & Mazda.



Automotive Key Padlock

Operates with **YOUR** Truck Key
No Extra Keys to Carry or Lose!

Simplify Fleet Management
 and Key Control



Improve Security
 and Equipment Protection

Increase Productivity
 Fewer Keys =
 Fewer Lockouts

1-Key Convenience
 Insert your key,
 Turn once,
 The lock learns your key!

Fits over 88%
 of light trucks on the road, plus
 select International
 and Sterling heavy trucks.

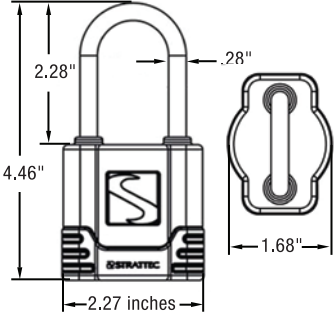

Typical Padlock		Automotive Padlock	Dimensions & Part Numbers			
	4 pin tumblers, no sidebar	6 Plate Tumblers & Sidebar prevents picking, bumping				
	Steel & brass construction	Superior Corrosion Resistance Chromate Plated, Cast Zinc Cylinder & Case				
	Very few key codes	Thousands of Key Codes				
	Open to the elements	Stainless Steel Lock Shutter keeps out weather & debris				
	Made in China	Made in USA				
	Extra keys	No extra keys to carry or lose				
			7013126	GM-A	75 GRV	
			7013127	GM-B	93 GRV	
			7013129	CHRYSLER	82 GRV	
			7013128	FORD	84 GRV	

ZEXX™

AUTO COLOGNE WAX



A simple to use carnauba spray wax and quick detailer, that not only leaves your vehicle with an incredible deep shine, but and a potent designer cologne or perfume scent that emanates up to 10 meters.

Three potent men's scents and a very impressionable women's scent. Highly refined white carnauba wax that delivers a deep, streak free shine.

Apply quick and easy with the Zexx atomizer spray trigger, then buff to a brilliant shine with a microfiber cloth. Place that microfiber cloth under your car seat or in your glove box and your car's interior will have that same designer scent for months.

Available in cases of 12 cans with 3 of each fragrance. Each case includes an easy to assemble counter top display.



Each case comes with an easy to assemble counter top display.

Remote Skins



Our New Flexible Remote Skins® Slip On to Protect a Car Remote!!

Customize - Made of soft, flexible neoprene to resist water damage and fraying.

Protect – Tough, clear vinyl window allows visibility of remote buttons and protects them from wear.

Repair – Slip the cover over a broken remote to make it usable again.

Available in three models: GM, Ford & Universal (fits most Toyota and Honda remotes).

Replacement Batteries



692497

Panasonic Button Cell CR2032

10 Individually wrapped batteries

APPLICATIONS:

- Ford IKT
- GM Flip Style
- GM Remotes



CR2016RVC

Replacement Button Cell CR2016

CR2025RVC

Replacement Button Cell CR2025

CR2032RVC

Replacement Button Cell CR2032

Silicone Remote Jackets

For Chrysler & Ford Remotes & Remote Heads

A simple solution to protect, distinguish, and prevent broken & scratched up car & truck remotes.

Ford 80-Bit IKTs



Chrysler/Dodge FOBs



Ford IKTs



A custom fit protective cover made out of a silicone based rubber that simply slides over your existing remote. Added features of this product include: damage prevention, replacement costs, accidental engagement of control functions, ability to reattach a broken remote, and personalization through a variety of colors.

Ultra-Sonic Parking Sensor

Park Your Car Exactly Where You Want It

The Striker Garage Parking Sensor is designed to take the guess work out of parking your car in tight garage spaces. It features adjustable, ultrasonic range finding technology to accurately locate your car within your desired parking constraints.

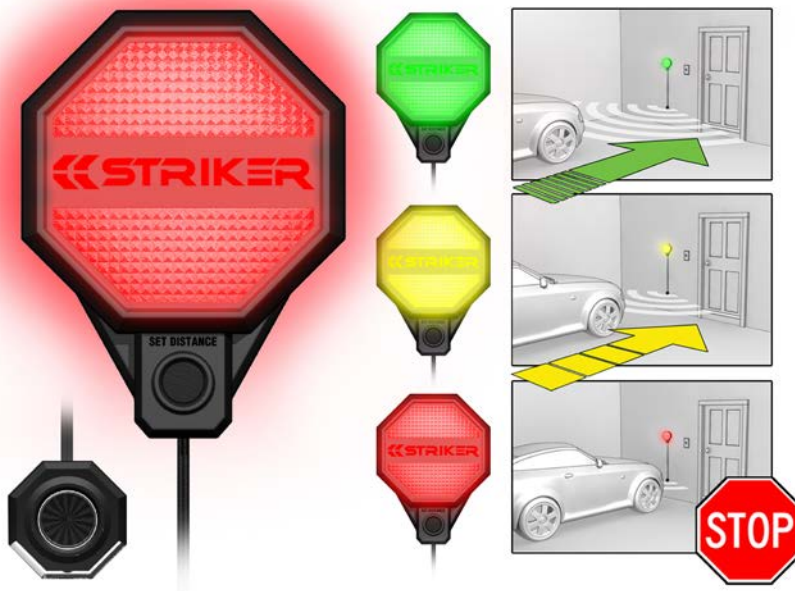

As the driver approaches the Striker Garage Parking Sensor they will see a green light indicating it is safe to proceed.

As the car nears the sensor, a yellow light will illuminate as a warning to slow down.

Finally, when the car is in the desired parking distance from the sensor, a red light will illuminate, signaling the driver to stop the car.

It makes parking as easy as 1,2,3!

The Striker Parking Sensor eliminates the dents and dings from garage “fender benders” and allows you to safely close the garage door every time. It is easy to install and comes complete with all mounting hardware, instructions and warranty.

Simply mount the sensor unit in front of the car at bumper level. Then mount the signal light in a position easily viewed from the driver's seat. Lastly, park your car exactly where you want it and press the set button. That's it!





Phone: (780) 451-3202

Toll Free: 1-866-557-3225

Fax: (780) 451-1982

Toll Free: 1-866-557-3226

5863 — 166 Avenue
Edmonton, AB T5Y 0J2
Canada

www.idkeyco.com